

JBS System GmbH

Clamping

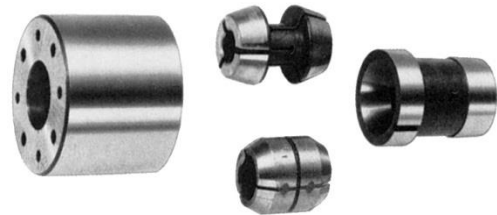

Guiding



Pick Up



JBS System GmbH

Kieler Strasse 118 • D 24119 KRONSHAGEN • Fon +49 431/ 5377-426 • Fax: +49 431 / 5377-487
E-Mail: info@jbs-system.com • <http://www.jbs-system.com>

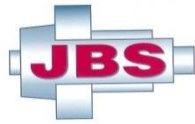

System GmbH

„We start there, where others have to give up.“

Here at JBS System GmbH, we act according to this principle and we are committed to looking at difficult problems and providing a solution.

Founded in 1982, the company has become one of the leading providers of flexible guide bush units for long automatic lathes over the last 30 years.

The JBS Flexible Guide Bushing for double-cone collets and pull-collets was developed in order to guide and/or clamp work material rods with a varying external diameter in a rotating as well as a stationary condition in Swiss type automatic lathes.

The drive for the flexible guide bushing is via a drive belt, a gearwheel or a driving dog or synchronous drive.

Opening, closing and clamping of the guide collets is by means of a pneumatic system with an adjustable pressure piece.

The pressure piece presses the guide collet against the fixed spindle cap, the guide collet begins to close and thus surrounds the work material rod.

Controlling of the JBS guide bushing is via 4 freely programmable M commands in the machine.

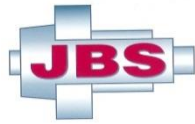

System GmbH

This is what speaks in favour of the JBS System

- no seizing any more
- collet guide runs synchronized to spindle and during the processing adjusts to material
- range of adjustment of the flexible guide collet system max. $\pm 0,3$ mm
- quick change from collet to collet: maximum 3 minute !
- No more the titherto time-consuming and complicated adjustment of the guide collet
- easy handling with loading magazine
- thanks to this novel system, for the first time ever, the necessary high metal removal rate in form cutting is made possible
- suitable for all materials: from plastics to highalloyed chrome steels in the version from ground to rolled material according to DIN standard 1013

Technical data:

Material diameter 1,0 mm to 40,0 mm

CNC- or CAM-controlling with serveral functions: opening - closing - clamping - gliding

Special sizes are possible

The JBS System can be applied to the following CNC Swiss bush-type automatic lathes:

Star, Citizen, Maier, HANWHA, Gildemeister, Manurhin/KMX, Tornos, Traub, Tsumami, Nomura, Strohm etc.

Technical modifications reserved

JBS System GmbH

Kieler Strasse 118 • D 24119 KRONSHAGEN • Fon +49 431/ 5377-426 • Fax: +49 431 / 5377-487
E-Mail:info@jbs-system.com • <http://www.jbs-system.com>

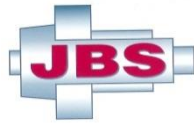

JBS overview DK-System for Star CNC Swiss Automatic

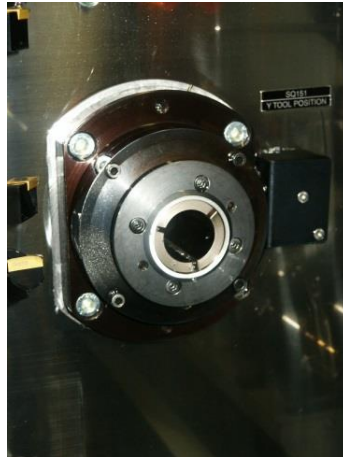

Ident.-Nr	Item description	Collet Typ	Info
188	SV- 20, Flexible Guide Bush Unit	1/28x40	up to Ø 20mm
196	SV-32J, Flexible Guide Bush Unit	3/42x50	available up to Ø 35mm
236	SV-12, Flexible Guide Bush Unit	1/28x40	up to Ø 12mm
274	SV-20/25, Flexible Guide Bush Unit	2/33x40	up to Ø 23mm
292	SR-32 J, Flexible Guide Bush Unit	3/42x50	available up to Ø 35mm
353	SR-20 J, Flexible Guide Bush Unit	1/28x40	up to Ø 20mm
368	SR-20/25 J, Flexible Guide Bush Unit	2/33x40	up to Ø 23mm
401	ST 38, Flexible Guide Bush Unit	6/48x60	available up to Ø 40mm
435	SW-20, Flexible Guide Bush Unit	1/28x40	up to Ø 20mm
437	SW-20/25, Flexible Guide Bush Unit	2/33x40	up to Ø 23mm
450	SR-20 RIV, Flexible Guide Bush Unit	1/28x40	up to Ø 20mm
451	SR-20/25 RIV, Flexible Guide Bush Unit	2/33x40	up to Ø 23mm
488	SV-38 R, Flexible Guide Bush Unit	6/48x60	available up to Ø 40mm
490	SB-20 RE, Flexible Guide Bush Unit	1/28x40	up to Ø 20mm
521	SB-20 RG, Flexible Guide Bush Unit	1/28x40	up to Ø 20mm
525	SB-20/25 RG, Flexible Guide Bush Unit	2/33x40	up to Ø 23mm
526	ST 20, Flexible Guide Bush Unit	1/28x40	up to Ø 20mm
527	ST 20/25, Flexible Guide Bush Unit	2/33x40	up to Ø 23mm
529	SB-12 RG, Flexible Guide Bush Unit	7/24x35	up to Ø 12mm
530	SW-12 RII, Flexible Guide Bush Unit	7/24x35	up to Ø 12mm

More model on request. Technical execution are subject to change without prior notice

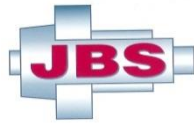

JBS System GmbH



JBS overview Pull-System for Star CNC Swiss Automatic

Ident.-Nr	Item description	Collet Typ	Info
344	SV-32-JII-Z, Flexible Guide Bush Unit	342/53x50	Pull-System, up to Ø 32mm
345	SR-32 J-Z, Flexible Guide Bush Unit	342/53x50	Pull-System, up to Ø 32mm
395	SR-10 J-Z, Flexible Guide Bush Unit	322/26x35	Pull-System, up to Ø 10mm
396	SV-20 Z, Flexible Guide Bush Unit	317/36x40	Pull-System, up to Ø 20mm
325	SR-20 RIII-Z, Flexible Guide Bush Unit	317/36x40	Pull-System, up to Ø 20mm
398	ECAS 20 T-Z, Flexible Guide Bush Unit	317/36x40	Pull-System, up to Ø 20mm
410	SR-20 J-Z, Flexible Guide Bush Unit	317/36x40	Pull-System, up to Ø 20mm
420	SV-20/25-Z, Flexible Guide Bush Unit	378/44x40	Pull-System, up to Ø 23mm
423	SB-20 Z, Flexible Guide Bush Unit	317/36x40	Pull-System, up to Ø 20mm
427	SB 16-Z, Flexible Guide Bush Unit	346/32x40	Pull-System, up to Ø 16mm
438	SW-20 Z, Flexible Guide Bush Unit	317/36x40	Pull-System, up to Ø 20mm
452	SR-20 RIV-Z, Flexible Guide Bush Unit	317/36x40	Pull-System, up to Ø 20mm
479	SA 16-Z, Flexible Guide Bush Unit	346/32x40	Pull-System, up to Ø 16mm
489	SV-38 R-Z, Flexible Guide Bush Unit	485/59x60	Pull-System, up to Ø 38mm
522	SB-20 RG-Z, Flexible Guide Bush Unit	317/36x40	Pull-System, up to Ø 20mm

More model on request. Technical execution are subject to change without prior notice

JBS System GmbH

Kieler Strasse 118 • D 24119 KRONSHAGEN • Fon +49 431/ 5377-426 • Fax: +49 431 / 5377-487
E-Mail: info@jbs-system.com • <http://www.jbs-system.com>



JBS System GmbH

JBS Chuck Systeme for Star CNC Swiss Automatic

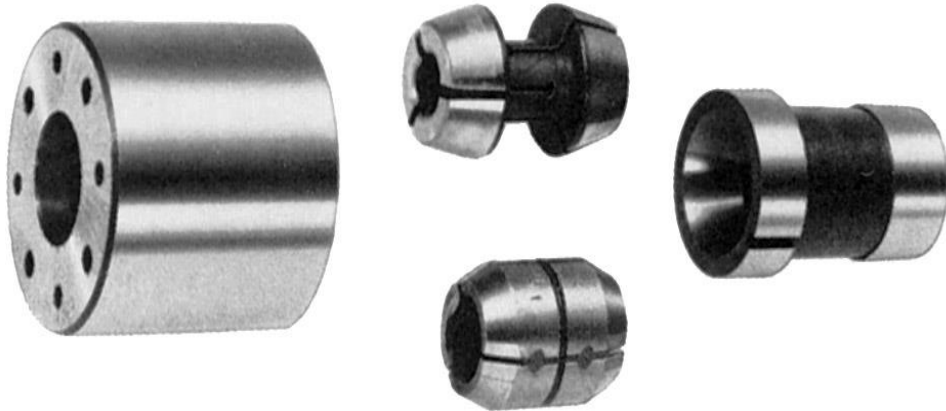

Ident.-Nr	Item description	Collet Typ	Info
183	SR-32 DKZ, Chuck	3/42x50	up to Ø 32mm
197	SV-32 J DKZ, Chuck	3/42x50	up to Ø 32mm
280	SR-20/25 RII DKZ, Chuck	2/33x40	up to Ø 23mm
281	SR-20 RII DKZ, Chuck	1/28x40	up to Ø 20mm
362	SR-32 J DKZ, Chuck	3/42x50	up to Ø 32mm
364	SR-32 JN DKZ, Chuck	3/42x50	up to Ø 32mm
374	SR-20 JN DKZ, Chuck	1/28x40	up to Ø 20mm
403	SV-32/36 J DKZ, Chuck	3/42x50	up to Ø 35mm
415	SV-32 J, Over grip chusk	J37	Ø on request
434	ECAS 20 T, Over grip chuck	J25	Ø on request
442	SR-32 J DKZ, Pick up chuck	3/42x50	up to Ø 32mm
448	SR-32 JN XL DKZ, Chuck	3/42x90	up to Ø 32mm
449	SR-32 J, Over grip chuck	J37	Ø on request
457	SR-20 RII, Over grip chuck	J25	Ø on request
460	SV-32 J DKZ, Pick up chuck	3/42x50	up to Ø 32mm
469	SB-16 EII DKZ, Chuck	1/28x40	up to Ø 32mm

More model on request. Technical execution are subject to change without prior notice

JBS System GmbH

Kieler Strasse 118 • D 24119 KRONSHAGEN • Fon +49 431/ 5377-426 • Fax: +49 431 / 5377-487
E-Mail: info@jbs-system.com • http://www.jbs-system.com

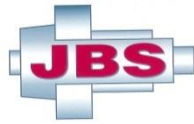

JBS overview DK-System for Citizen CNC Swiss Automatic

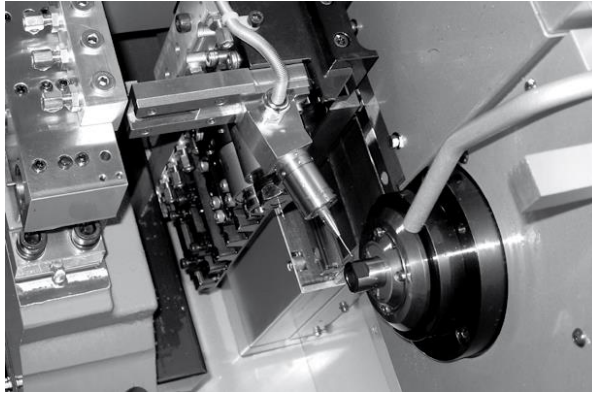

Ident.-Nr	Item description	Guide collet	Info
219	L 520, Flexible guide bush unit	1/28x40	up to Ø 20mm
224	M32, Flexible guide bush unit	3/42x50	available up to Ø 35mm
246	C 16, Flexible guide bush unit (insert)	7/24x35	available up to Ø 18mm
249	M 16, Flexible guide bush unit	7/24x35	available up to Ø 18mm
260	R 04-Neukomm, Guide bush unit	FZ Typ 51.001/351	With synchronous drive up to max. 6.000 rpm
293	L 720, Flexible guide bush unit	1/28x40	up to Ø 20mm
294	L 632, Flexible guide bush unit	3/42x50	up to Ø 32mm
301	L 432, Flexible guide bush unit (insert)	3/42x50	available up to Ø 35mm
309	L320, Flexible guide bush unit	3/42x50	available up to Ø 35mm
331	C32, Flexible guide bush unit	3/42x50	up to Ø 32mm
334	R07-Neukomm, Guide bush unit	FZ Typ 3.001	With synchronous drive up to max. 6.000 rpm
335	A 20 VII, Flexible guide bush unit	1/28x40	up to Ø 20mm
359	A 20 VI, Flexible guide bush unit	1/28x40	up to Ø 20mm
363	A 32, Flexible guide bush unit	3/42x50	up to Ø 32mm
412	L 20 E VIII, Flexible guide bush unit	1/28x40	up to Ø 20mm
440	M432 VIII, Flexible guide bush unit	3/42x50	available up to Ø 35mm
445	L 20 X, Flexible guide bush unit	1/28x40	up to Ø 20mm
470	A20/25 VII, Flexible guide bush unit	2/33x40	up to Ø 23mm
480	B16 E, Flexible guide bush unit	7/24x35	up to Ø 16mm
483	L12, Flexible guide bush unit	7/24x35	up to Ø 12mm
495	A232, Flexible guide bush unit	3/42x50	available up to Ø 35mm
511	L220 XII, Flexible guide bush unit	1/28x40	up to Ø 20mm
513	L220/25 XII, Flexible guide bush unit	2/33x40	up to Ø 25mm

More model on request. Technical execution are subject to change without prior notice

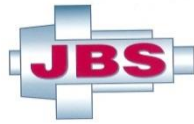

JBS overview Pull-System for Citizen CNC Swiss Automatic



Ident.-Nr	Item description	Guide collet	Info
287	R 07-Z, Flexible guide bush unit	322/26x35	With synchronous drive up to max. 6.000 rpm
306	M 16-Z, Flexible guide bush unit	346/32x40	Pull-System, up to Ø 16mm
316	L 720-Z, Flexible guide bush unit	317/36x40	Pull-System, up to Ø 20mm
355	C 16, Flexible guide bush unit (insert)	346/32x40	Pull-System, up to Ø 16mm
394	A 20 VII-Z, Flexible guide bush unit	317/36x40	Pull-System, up to Ø 20mm
399	A 32-Z, Flexible guide bush unit	342/53x40	Pull-System, up to Ø 32mm
400	K12-Z/K-16-Z, Flexible guide bush unit	346/32x40	Pull-System, up to Ø 16mm
402	M32-Z, Flexible guide bush unit	342/53x40	Pull-System, up to Ø 32mm
413	L 20 E VIII-Z, Flexible guide bush unit	317/36x40	Pull-System, up to Ø 20mm
441	M432-Z VIII, Flexible guide bush unit	342/53x40	Pull-System, up to Ø 32mm
446	L 20 X-Z, Flexible guide bush unit	317/36x40	Pull-System, up to Ø 20mm
484	L 12-Z, Flexible guide bush unit	346/32x40	Pull-System, up to Ø 12mm
493	A 232-Z, Flexible guide bush unit	342/53x40	Pull-System, up to Ø 32mm
510	M 416, Flexible guide bush unit	346/32x40	Pull-System, up to Ø 16mm
512	L 220 XII-Z, Flexible guide bush unit	317/36x40	Pull-System, up to Ø 20mm

More model on request. Technical execution are subject to change without prior notice

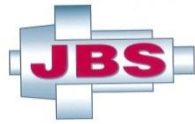

JBS overview DK-System for Hanwha CNC Swiss Automatic

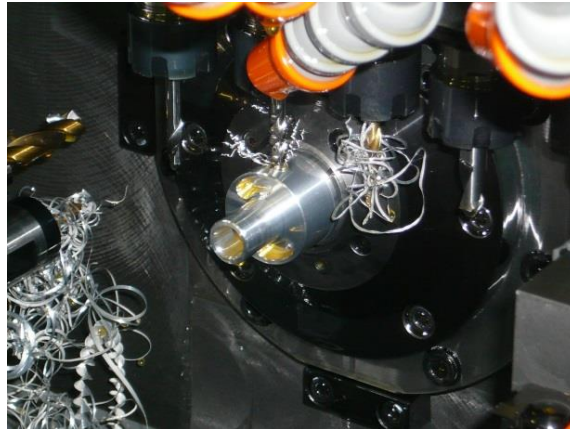

Ident.-Nr	Item description	Guide collet	Info
241	SL 26, Flexible guide bush unit	2/33x40	up to Ø 26mm
286	SL 32 HPD, Flexible guide bush unit	3/42x50	up to Ø 32mm
299	SL 35 HP, Flexible guide bush unit	6/48x60	up to Ø 35mm
308	XD 20H, Flexible guide bush unit	1/28x40	up to Ø 20mm
314	XD 26H, Flexible guide bush unit	2/33x40	up to Ø 26mm
315	STL 35 H, Flexible guide bush unit	6/48x60	up to Ø 35mm
320	STL 32 H, Flexible guide bush unit	3/42x50	up to Ø 32mm
337	XD 32 H, Flexible guide bush unit	3/42x50	up to Ø 32mm
347	XP 12, Flexible guide bush unit	7/24x35	up to Ø 12mm
348	XP 20, Flexible guide bush unit	1/28x40	up to Ø 20mm
365	STL 38 H, Flexible guide bush unit	6/48x60	up to Ø 38mm
429	XD 38 H, Flexible guide bush unit	6/48x60	up to Ø 38mm
430	XD 20 J, Flexible guide bush unit	1/28x40	up to Ø 20mm
433	XD-12, Flexible guide bush unit	1/28x40	up to Ø 12mm
453	XD 20 V, Flexible guide bush unit	1/28x40	up to Ø 20mm

More model on request. Technical execution are subject to change without prior notice

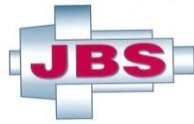

JBS System GmbH

JBS overview Pull-System for Hanwha CNC Swiss Automatic

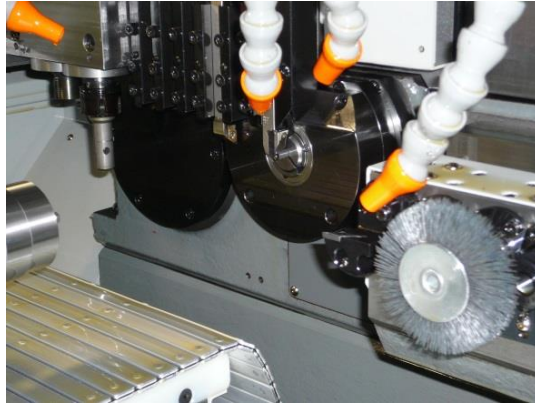

Ident.-Nr	Item description	Guide collet	Info
326	XD 20 H-Z, Flexible guide bush unit	317/36x40	Pull-System, up to Ø 20mm
431	STL 32-Z H, Flexible guide bush unit	342/53x50	Pull-System, up to Ø 32mm
454	XD 20 V, Flexible guide bush unit	317/36x40	Pull-System, up to Ø 20mm
486	STL 38 H-Z, Flexible guide bush unit	485/59x60	Pull-System, up to Ø 38mm

More model on request. Technical execution are subject to change without prior notice

JBS System GmbH

Kieler Strasse 118 • D 24119 KRONSHAGEN • Fon +49 431/ 5377-426 • Fax: +49 431 / 5377-487
E-Mail: info@jbs-system.com • <http://www.jbs-system.com>

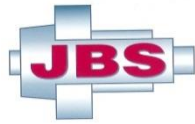

JBS overview DK-System for Maier CNC Swiss Automatic

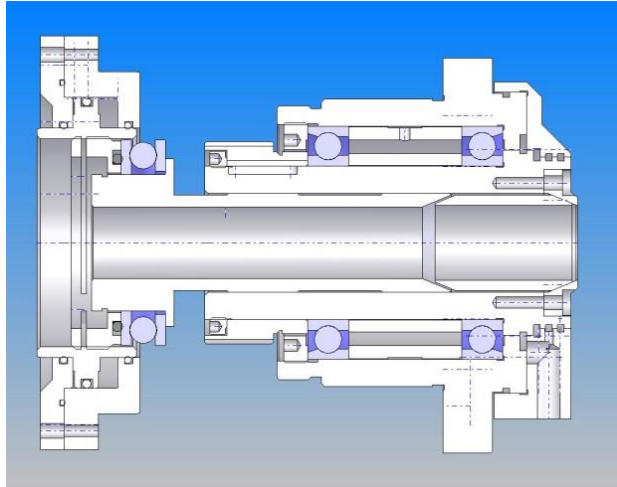

Ident.-Nr	Item description	Guide collet	Info
250	ML 32 Serie A-F, Flexible guide bush unit	3/42x50	Available up to Ø 35mm
267	ML 26 Serie A-F, Flexible guide bush unit	2/33x40	up to Ø 26mm
268	ML 20 Serie A-F, Flexible guide bush unit	1/28x40	up to Ø 20mm
352	ML 36 Serie A-F, Flexible guide bush unit	6/48x60	up to Ø 36mm
471	ML 32 Serie A-F/56, Flexible guide bush unit	3/42x50	Available up to Ø 35mm
472	ML 26 Serie A-F/56, Flexible guide bush unit	2/33x40	up to Ø 26mm
473	ML 20 Serie A-F/56, Flexible guide bush unit	1/28x40	up to Ø 20mm
477	ML 36 Serie A-F/56, Flexible guide bush unit	6/48x60	up to Ø 36mm

More model on request. Technical execution are subject to change without prior notice

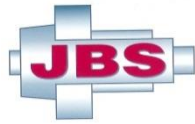

JBS overview Pull-System for Maier CNC Swiss Automatic

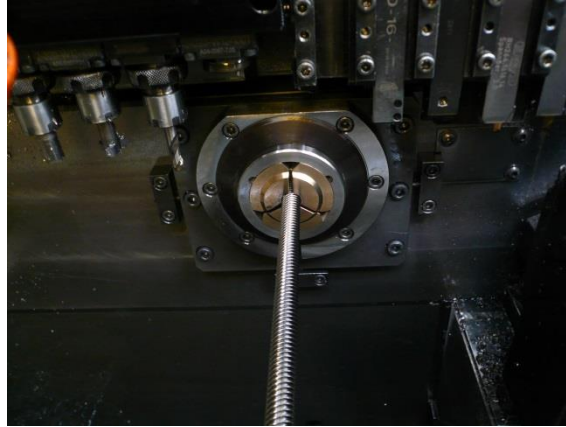

Ident.-Nr	Item description	Guide collet	Info
338	ML 32-Z Serie A-F, Flexible guide bush unit	342/ 53x50	Pull-System, up to Ø 32mm
333	ML 26-Z Serie A-F, Flexible guide bush unit	342/ 53x50	Pull-System, up to Ø 26mm
379	ML 20-Z Serie A-F, Flexible guide bush unit	317/36x40	Pull-System, up to Ø 20mm
475	ML 32-Z Serie A-F/56, Flexible guide bush unit	342/ 53x50	Pull-System, up to Ø 32mm
474	ML 26-Z Serie A-F/56, Flexible guide bush unit	342/ 53x50	Pull-System, up to Ø 26mm
476	ML 20-Z Serie A-F/56, Flexible guide bush unit	317/36x40	Pull-System, up to Ø 20mm

More model on request. Technical execution are subject to change without prior notice

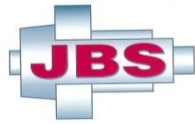

JBS overview DK-System for Tornos CNC Swiss Automatic

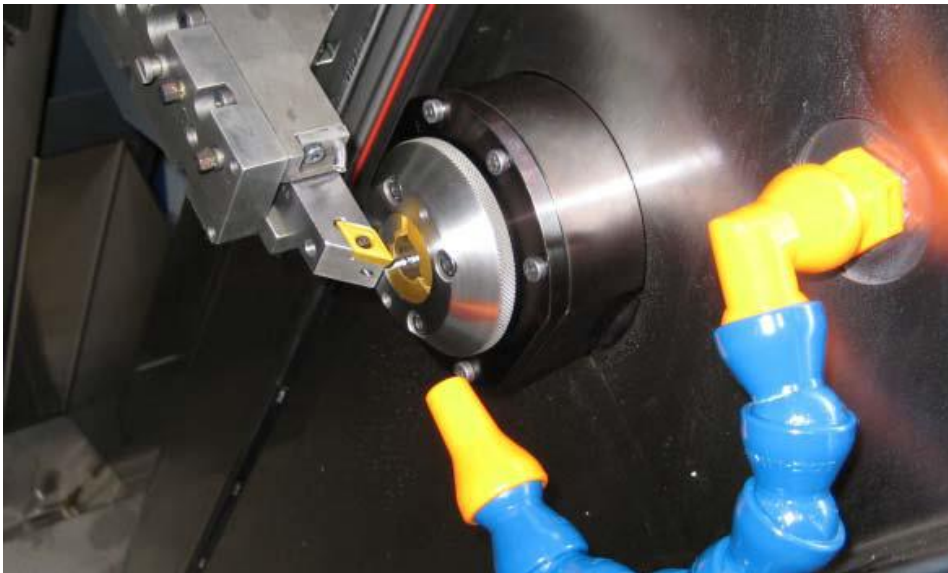

Ident.-Nr	Item description	Guide collet	Info
208	Deco 2000/25, Flexible guide bush unit	2/33x40	up to Ø 25mm
209	Deco 2000/20, Flexible guide bush unit	2/33x40	up to Ø 20mm
222	Deco 2000/13, Flexible guide bush unit	7/24x35	up to Ø 13mm
270	Deco 2000/16, Flexible Führungsbuchse	7/24x35	up to Ø 16mm
332	Sigma 20, Flexible guide bush unit	2/33x40	up to Ø 25mm

More model on request. Technical execution are subject to change without prior notice



JBS overview DK-System for Tornos CNC Swiss Automatic



Ident.-Nr	Item description	Guide collet	Info
371	Deco 10 Z, Flexible guide bush unit	322/26x35	Pull-System, up to Ø 10mm
436	Deco 2000/25-Z, Flexible guide bush unit	378/44x40	Pull-System, up to Ø 25mm
535	ST 26-Z, Flexible guide bush unit	378/44x40	Pull-System, up to Ø 25mm
537	EvoDeco 16-Z, Flexible guide bush unit	346/32x40	Pull-System, up to Ø 16mm

More model on request. Technical execution are subject to change without prior notice

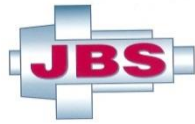

JBS System GmbH

JBS overview Pull-System for Nomura CNC Swiss Automatic

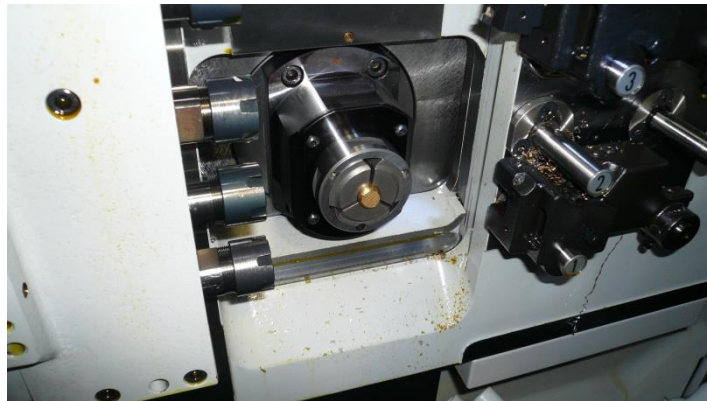

Ident.-Nr	Item description	Guide collet	Info
377	NN 25-Z YB, Flexible guide bush unit	378/44x40	Pull-System, up to Ø 26mm
388	NN 32-Z YB, Flexible guide bush unit	342/53x50	Pull-System, up to Ø 32mm
456	NN 20-Z YB, Flexible guide bush unit	378/44x40	Pull-System, up to Ø 20mm

More model on request. Technical execution are subject to change without prior notice

JBS System GmbH

Kieler Strasse 118 • D 24119 KRONSHAGEN • Fon +49 431/ 5377-426 • Fax: +49 431 / 5377-487
E-Mail: info@jbs-system.com • <http://www.jbs-system.com>



JBS System GmbH

JBS overview Pull-System for Tsugami CNC Swiss Automatic

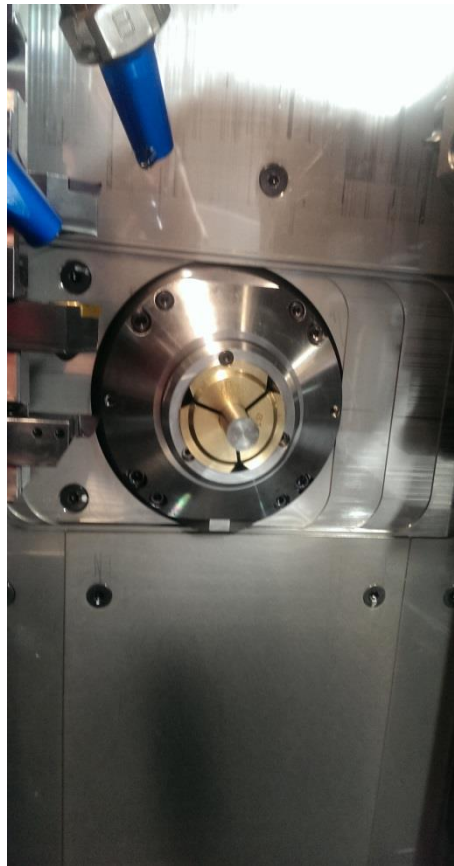

Ident.-Nr	Item description	Guide collet	Info
492	BO 266-II-Z, Flexible guide bush unit (insert)	378/44x40	Pull-System, up to Ø 26mm
497	BO 326-II-Z, Flexible guide bush unit (insert)	342/53x50	Pull-System, up to Ø 32mm
505	HS 327-Z, Flexible guide bush unit (insert)	342/53x50	Pull-System, up to Ø 32mm

More model on request. Technical execution are subject to change without prior notice

JBS System GmbH

Kieler Strasse 118 • D 24119 KRONSHAGEN • Fon +49 431/ 5377-426 • Fax: +49 431 / 5377-487
E-Mail: info@jbs-system.com • <http://www.jbs-system.com>

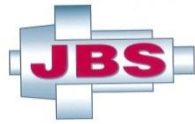

Collets Article-Number Key Pincés de guidage article-nom.-clef

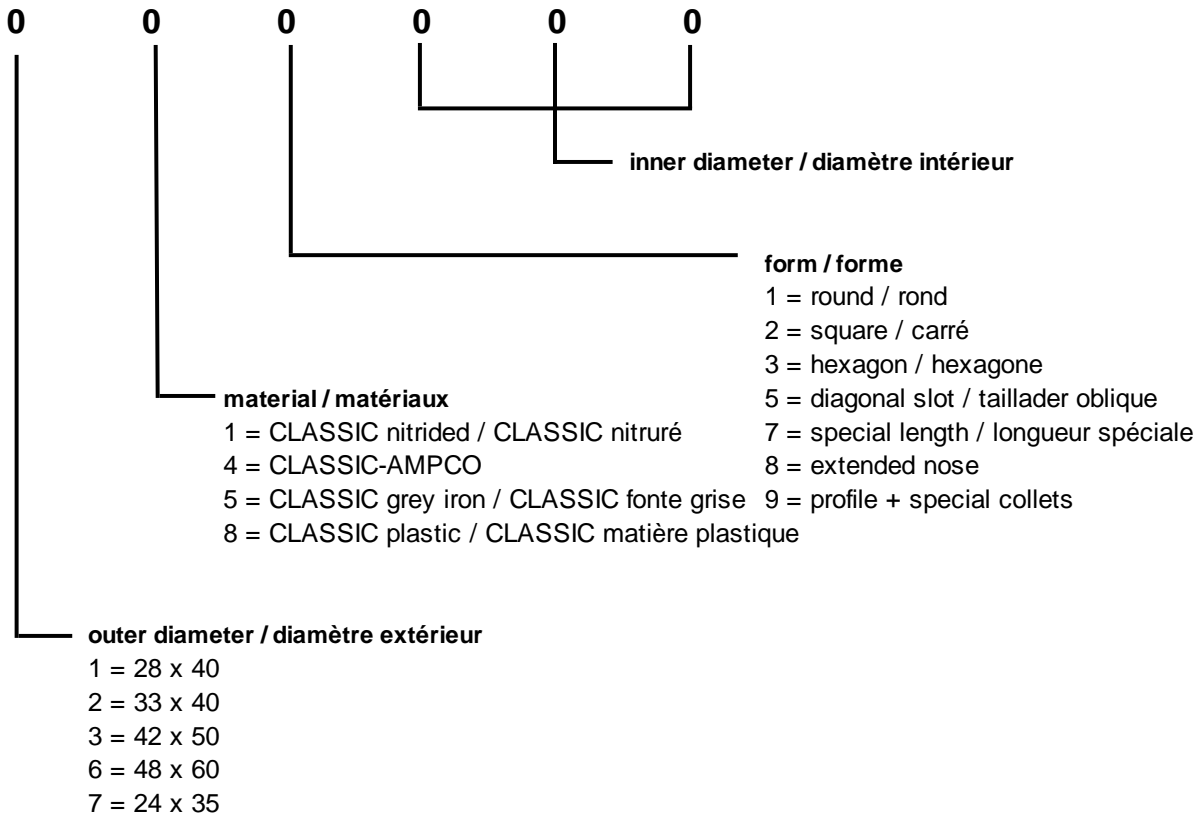

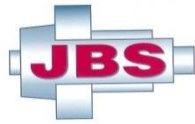

System GmbH

Material Recommendation for JBS double cone guide collets



FZ CLASSIC nitrided:

- to reduce wear (copper/aluminium)

FZ CLASSIC-AMPCO:

- Bronze base alloy for titanium and chromium

FZ CLASSIC grey iron:

- for profiled bar material (rolled or ground) starting material with varying tolerances



FZ CLASSICPlus grey iron:

- for profiled bar material (rolled or ground) starting material with varying tolerances, with chip cover cap and retainer ring

FZ CLASSICPlus AMPCO:

- Bronze base alloy for titanium and chromium with chip cover cap and retainer ring

FZ CLASSICPlus nitrided:

- to reduce wear (copper/aluminium) with chip cover cap and retainer ring

JBS System GmbH

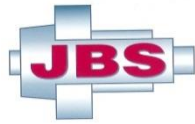

JBS System GmbH

Pull Collets Article-Number Key

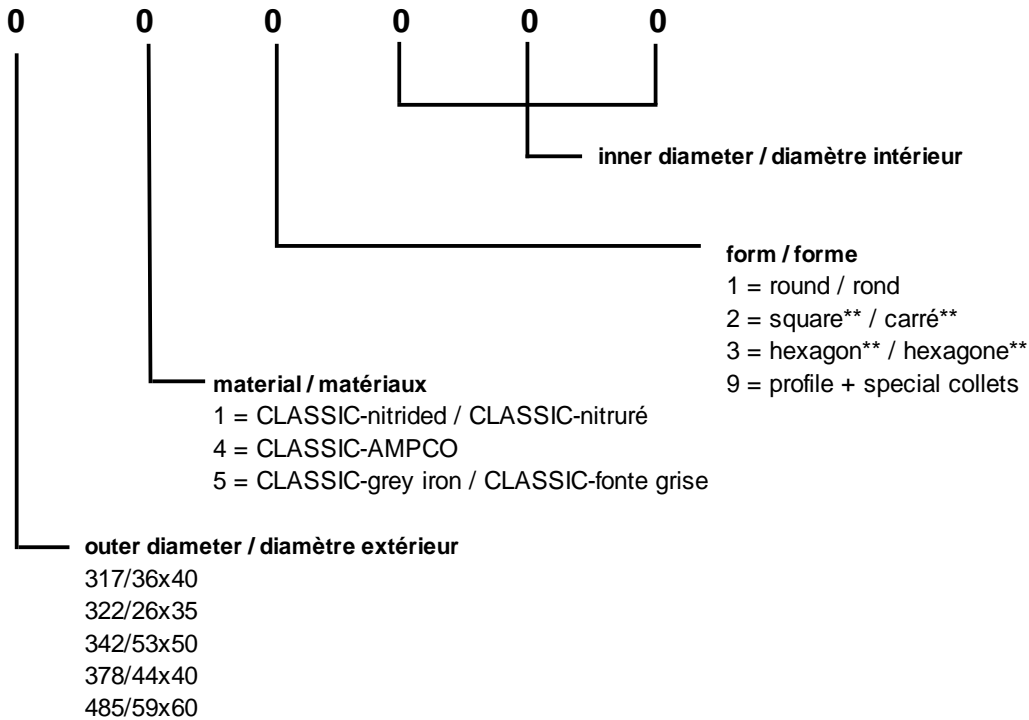

JBS System GmbH

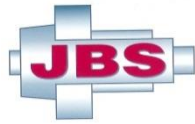

JBS System GmbH

Air Control for JBS Flexible Guide Bush Unit



JBS System GmbH

Kieler Strasse 118 • D 24119 KRONSHAGEN • Fon +49 431/ 5377-426 • Fax: +49 431 / 5377-487
E-Mail: info@jbs-system.com • <http://www.jbs-system.com>